







PRODUCT NAME
ACHEM ALL STAINLESS STEEL NAMUR SOLENOID VALVE
MODEL NO.
ALV610F3C4
DESCRIPTION OF THE PRODUCT
Based on NAMUR standard, the same ACHEM STAINLESS STEEL NAMUR solenoid valve can be adapted for 3/2 NC or 5/2 functions. Armed with the stainless steel(316) body and enclosure of coil, this one is excellent for use in corrosive and hazardous atmospheres . Working pressure from 2bar to 8 bar and the working voltage from 12-48VDC, 110-240VAC.
APPROVED BY
      IP66



SPOOL VALVE TECHNICAL DATA	
Spool valve Body	Stainless Steel (316)
Seal	Buna N
Materials in contact with fluid	Stainless Steel (316) Glass-filled PA, POM, Buna N
Function	5/2 and 3/2NC, Monostable CV =1.1(19.63mm ²), 1082 l/min
Air Ports	Air ports 1/4" BSPP or NPT
Assembly and Connection	24x32 Namur, Manual override on body
Fasteners	Stainless steel
Environment	Type 4, 4X (indoor and outdoor)
Medium Temperature	-25°C ~ 80°C
Working Pressure	2 ~ 8 bar
Working Medium	less than 40µm filtered and dried air
Bistable(ALV620F3C4)	available on requiring
Working life	more than 1000,000 cycle (On the normal working condition)

Coil Specification(C4)	
Operating Voltage	12/24/48VDC-3.5W 110/210/220/240VAC-4VA(50/60HZ)
Coil Enclosure	stainless steel(316)
Wiring Connector	M20-1.5 or 1/2"NPT, Terminal Strip
Insulation Protection	F Class Coil
Insulated voltage	1000V
Duty factor	100% ED
Weather Proof	IP66
Area Classification	Ex d IIC T6(Class 1,Division 1,Group ABCD)
Operating Temp.	-20°C ~ 60°C

- Advanced Features**
- 1, All the exhaust ports of this spool valve are connectable, providing better environmental protection.
 - 2, The valves armed with "environmentally-protected structure" offer environmental protection against the ingress of liquids, dusts or other foreign matter.

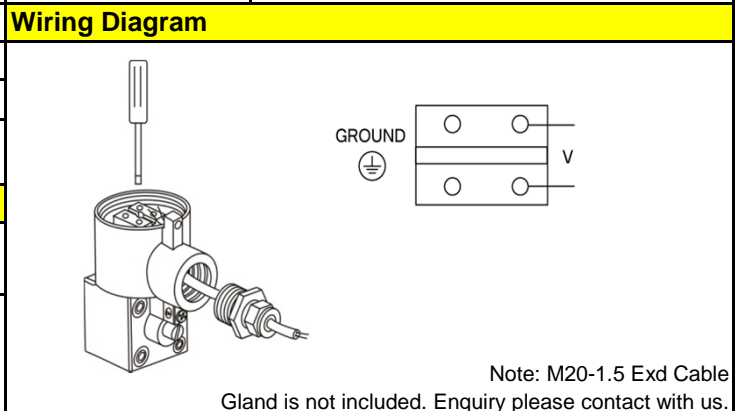

DRAWING AND MOUNTING

